

**Institute de Mathématique et  
Informatique  
Licence Math L1  
Module : Electronique, composants des systèmes**

**TD N° 01**

**Chapter 1. Electronic system versus computer system**

**Exercice 1 : Generalities**

- 1.1. Give a correct definition to an automated digital electronic system.
- 1.2. What is a Computer system ?
- 1.3. What is a computer ?

**Chapter 2. Components of a computer**

**Exercice 2 : Von Neumann Architecture**



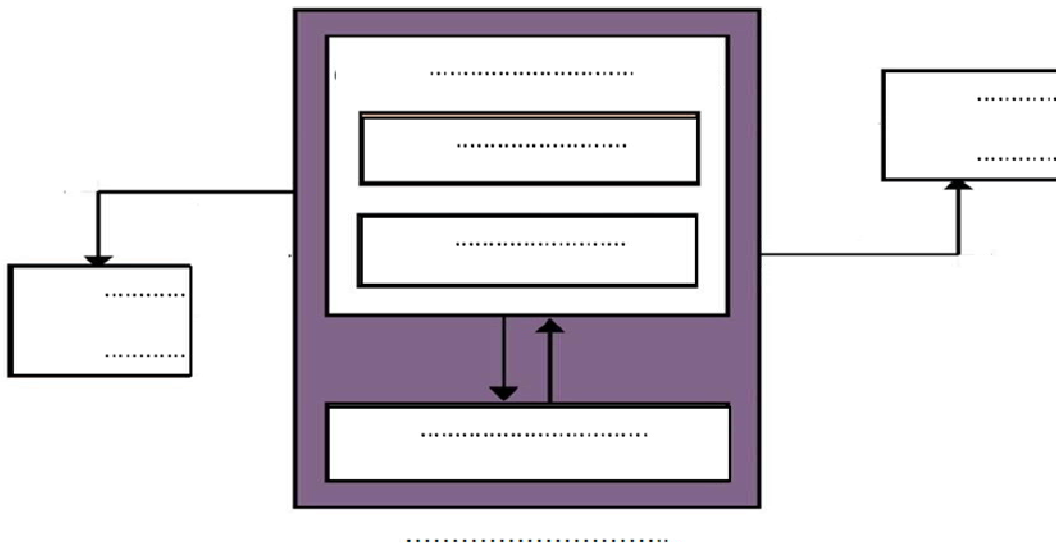







- 2.1. Complete the diagram below
- A2.1. I complete the diagram below

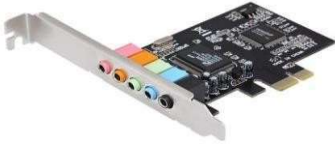
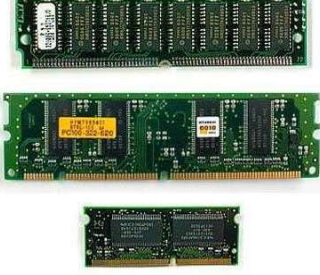

- 2.2. What is the role of Central Processing Unit (CPU) in Von Neumann architecture ?
- 2.3. According to Von Neumann architecture, the CPU is composed from two main units The ALU and
- 2.4. Describe the role of Inputs devices and Outputs devices in Von Neumann architecture ?

**Exercice 3 : Composition of a Personal Computer**

- A3.1. In the table below, I indicate the correspondent name to each picture.

			
Drive CD/DVD	Floppy drive	Power supply	Motherboard
			
Sound card	RAM (Random Access Memory)	CPU (Central Processing Unit) / Microprocessor	Hard disk
			
Graphic card	Socket (for CPU)	Network card	Chipset

- 3.2. Give three examples of Input devices.
- 3.3. Give three examples of Output devices.
- 3.4. Give three examples of Input/Output devices.

**Exercise 4 :** Composition of a Personal Computer (The central unit seen from the outside)

#### 4.1. Front face

Number Designation

1	.....
2	.....
3	.....
4	.....
5	.....
6	.....
7	.....
8	.....
9	.....
10	.....
11	.....

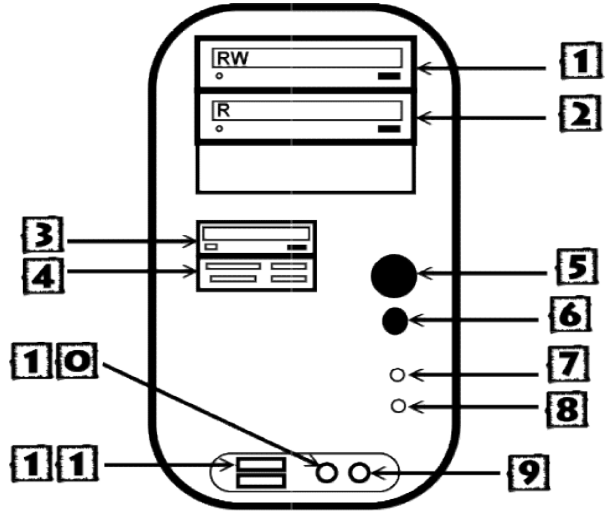

Face Avant / الوجه الأمامي

#### 4.2. Back Side

Number Port Attached component

1	.....	.....
2	.....	.....
3	PS Port /2 (green)	.....
4	PS Port /2 (purple)	.....
5	.....	.....
6	Com Port (serial)	.....
7	VGA Port (bleue)	.....
8	..... (green)	.....
9	..... (bleue)	.....
10	..... (pink)	.....
11	.....	.....
12	LPT Port (Parallel)	.....
13	Joystick Port	.....
14	.....	.....

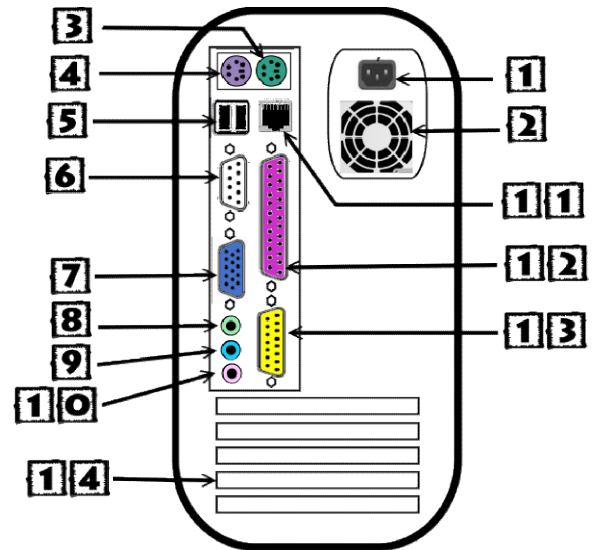

Face Arrière / الوجه الخلفي